

Q186 答え C

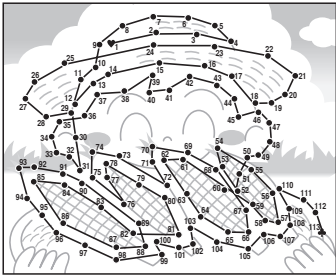

Q185 答え B

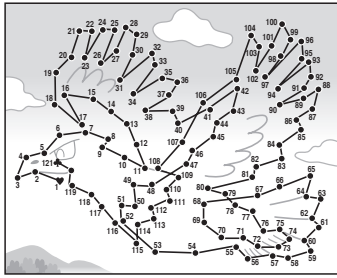

Q184 答え A

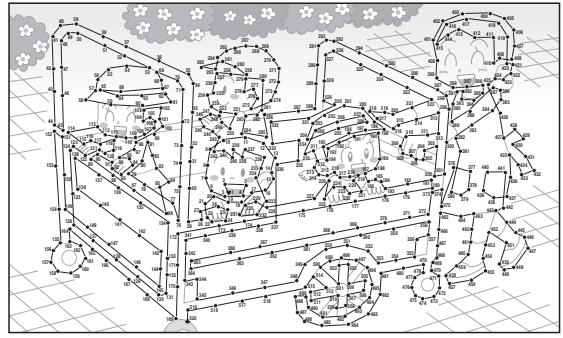

Q192 答え A

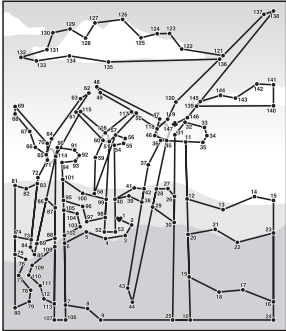

Q191 答え A

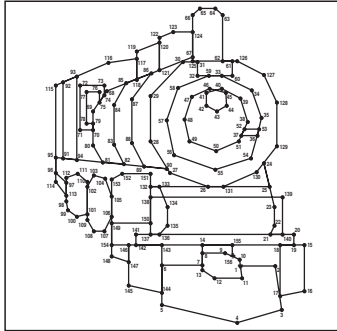

Q194 答え C

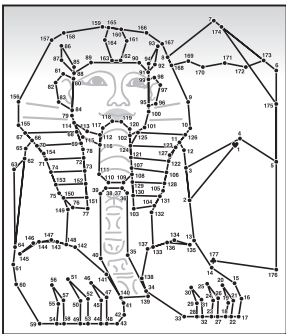

Q193 答え C

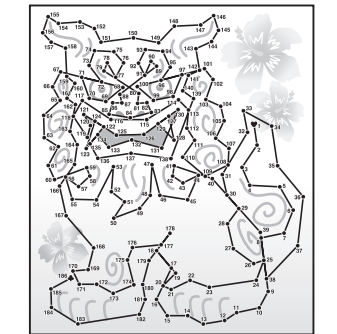

初級てんつなぎ⑤

Q188 答え 砂時計

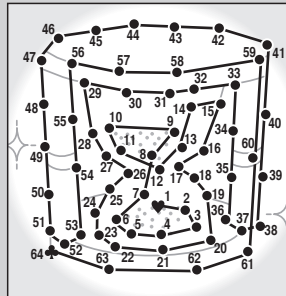

Q187 答え 懐中時計

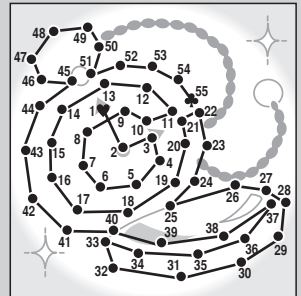

Q190 答え 柱時計

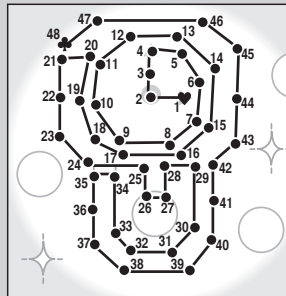

Q189 答え 日時計

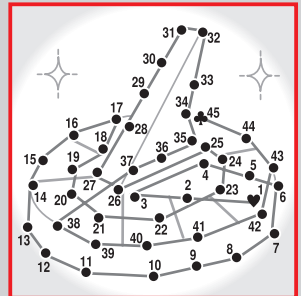

初級てんつなぎ⑥

Q200 答え 馬

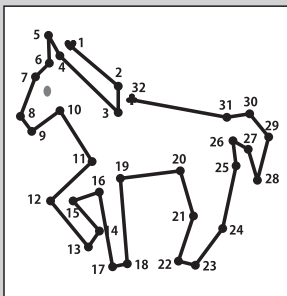

Q199 答え 牛

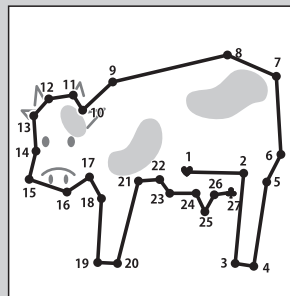

Q202 答え 豚

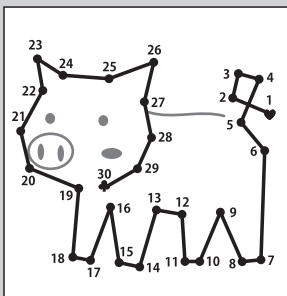

Q201 答え 羊

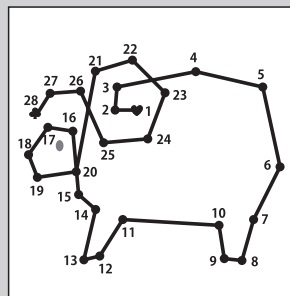

三文字熟語パズル

Q195 答え B

Q196 答え C

Q197 答え B

Q198 答え A

漢字を並べてできる四字熟語「義理人情」